

YCQ2 Series

Automatic Transfer Switch

OPERATION INSTRUCTION

Standard: IEC 60947-6-1

CNC

Deliver
Power For Better Life

 Before installing and using this product, please read this manual carefully and pay more attention to safety.

1. Matters Needing Attention



Dangerous

- Before installing or operating the product, please read this user manual. Only professionals could install, adjust, repair or maintain the product.
- Many parts of this product include control circuit board could not touch when the switch at work situation. Must use insulated tools.
- Could not touch those unprotected components or electric terminal screw.
- Before maintenance the product, the following measures should be taken: 1. Disconnect all power. 2. Put a "Forbidden closing" sign on the switch. 3. Lock switch in the off position.

Warning

- **The voltage is not consistent**

Before input power supply, please ensure the power voltage suitable for the switch rated voltage. If the voltage is not consistent, the product may be damaged. If using not in accordance with the user manual, the product may be damaged too.

2. Installation Steps

- Product delivery
 1. Check and confirm the product is the product that you ordered.
 2. Open the package, check the product if it was damaged during the transit.
- Check the voltage
 1. Check and ensure the power voltage suitable for the switch rated voltage.
- Install the product
 1. Installing the product according to this user manual.
 2. Installing all the external parts.
- Wiring
 - Connect main circuit.
 - Connect control circuit.
- Set
 - According to the actual situation and user manual to setting the operating parameter.

3. Product Model And Meanings

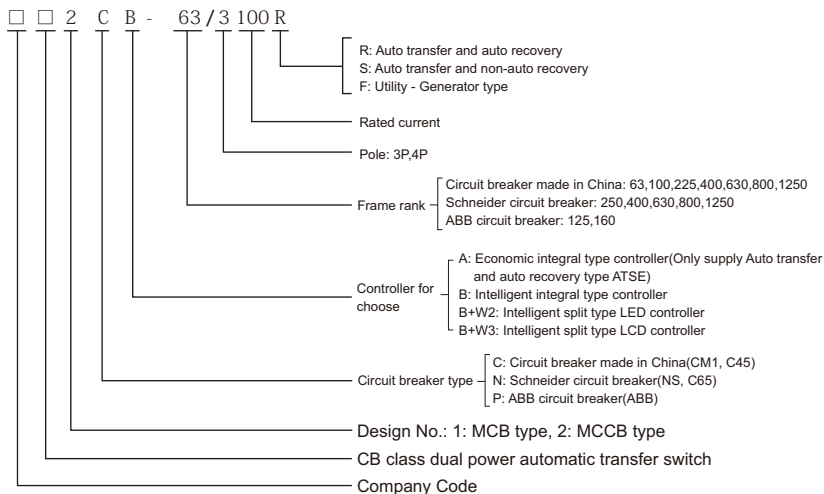

4. Features And Functionality Of Controller

Automatic transfer switch according power supply condition and the parameter that user set to choose if transfer from one power to the other power. It's function depends on the controller. There are 4 types(A,,B,B+W2 and B+W3) of controller. The features and functionality of controller as following.

Controller	A type Controller	B type Controller	B+W2 type Controller	B+W3 type Controller
Working power supply	AC160-250V 50/60Hz		DC12V(Provided by the inside of B type controller)	
Installation	Integral type		Split type	
Position	2 positions		3 positions	
Mode of operation	Auto and manual		Auto,manual and electro-manual operation	
Voltage monitoring function	3 phase loss monitoring		3 phase over-voltage,under-voltage and phase loss monitoring	
Frequency monitoring function	X		Frequency monitoring	
Generator control	X		A set of 3A relay dry contact	
Fire linkage control	X		Passive contact input,with a set of normally open passive signal feedback contact	
Mode of conversion	Auto transfer and auto recovery		According to user's requirement could set at Auto transfer and auto recovery, Auto transfer and non-auto recovery or Utility-Generator type mode	
Display	Indicator light display		LED display	LCD display
Conversion time delay	Constant 0.5s		0.5s-60s continuous adjustable	
Return time delay	Constant 0.5s		0.5s-60s continuous adjustable	

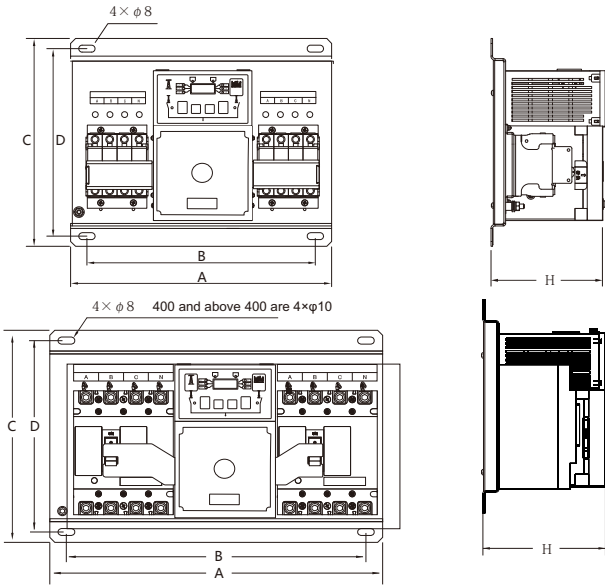

5. OUTLINE AND INSTALLATION DIMENSION



Dimension Model	A		B		C	D	H
	3P	4P	3P	4P			
□□1C- 63	285	320	245	280	255	230	141
□□1N- 63	285	320	245	280	255	230	141
□□1P- 63	285	320	245	280	255	230	141
□□2C- 63	305	355	265	315	255	230	141
□□2C- 100	335	395	295	355	255	230	141
□□2C- 225	365	435	325	395	255	230	155
□□2C- 400	491	587	431	527	330	300	215
□□2C- 630	524	640	464	580	330	300	215
□□2C- 800	580	720	520	660	340	310	215
□□2C- 1250	580	720	520	660	415	385	290
□□2N- 250	355	425	315	385	255	230	148
□□2N- 630	497	587	437	527	355	325	215
□□2P- 125	305	355	265	315	255	230	155
□□2P- 160	335	395	295	355	255	230	155

6. CONTROLLER INSTRUCTION

6.1 A type controller panel instruction

Indicator light style	Meaning of indicate light
	L1,L2,L3 Normal power 3 phase voltage indication (The indicator light lit means the voltage of this phase is normal)
	L1,L2,L3 Emergency power 3 phase voltage indication (The indicator light lit means the voltage of this phase is normal)
	Test ● Test status indicator light (The indicator light lit means the switch in manual test status) Auto ● Auto status indicator light (The indicator light lit means the switch in auto status)



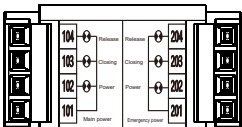

6.2 A type controller terminal and wiring explain

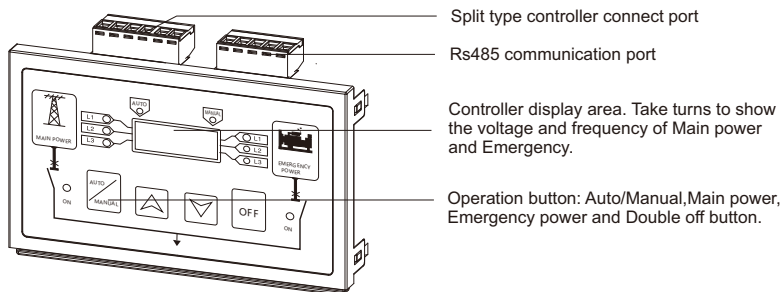
Wiring terminal style	Wiring terminal requirement and wiring explain
	<p>① 101~104: Main power exterior status indicator light signal (Active AC220V/0.5A). 101--Indicator light public Neutral line, 102--Main power indicator light output, 103--Main power closing signal output, 104--Main power release signal output.</p> <p>② 201~204: Emergency power exterior status indicator light signal(Active AC220V/0.5A). 201--Indicator light public Neutral line, 202--Emergency power indicator light output, 203--Emergency power closing signal output, 204--Emergency power release signal output.</p>



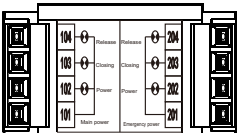

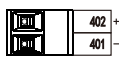
6.3 B type controller instruction



6.4 B type controller terminal and wiring explain



Wiring terminal style	Wiring terminal requirement and wiring explain
 <p>100-204: Main power exterior status indicator light signal (Active AC220V/0.5A). 101-Indicator light public Neutral line, 102-Main power indicator light output, 103-Main power closing signal output, 104-Main power release signal output. 201-204: Emergency power exterior status indicator light signal (Active AC220V/0.5A). 201-Indicator light public Neutral line, 202-Emergency power indicator light output, 203-Emergency power closing signal output, 204-Emergency power release signal output.</p>	<p>① 101~104: Main power exterior status indicator light signal (Active AC220V/0.5A). 101-Indicator light public Neutral line, 102-Main power indicator light output, 103-Main power closing signal output, 104-Main power release signal output.</p> <p>② 201~204: Emergency power exterior status indicator light signal (Active AC220V/0.5A). 201-Indicator light public Neutral line, 202-Emergency power indicator light output, 203-Emergency power closing signal output, 204-Emergency power release signal output.</p>
 <p>304: Fire fighting input (Passive contact) 303: Fire fighting feedback signal output 302: Fire fighting feedback signal output 301: Fire fighting feedback signal output</p>	<p>③ 303-304: Passive fire fighting input, connect this 2 ports effective. ATSE will transfer to double off position. After fire fighting signal disappear, if ATSE is in Automatic status, ATSE will transfer to the normal power. If the Main power and Emergency power both normal, ATSE will transfer to Main power. 301-302: Fire fighting feedback signal output. When ATSE transfer to double off position, ports will output a closed signal.</p>
 <p>402: + 401: -</p>	<p>④ 401-402: Controller DC auxiliary power input port (DC10V 15V/0.5A). Controller connect into Aux power aim: On Utility-Generator mode, control Generator start delay time, if without Aux power, generator start delay time is 0.</p>
 <p>Generator start control signal output 503 502 501</p>	<p>⑤ 503 port is public port, 502 port is normal closed port, 501 port is normal open port. 503-502: Start generator passive port. 503-501: Stop generator passive port. (Contact capacity: AC220V/3A) Start generator signal output condition: When Main power occur over-voltage, under-voltage, phase loss etc. fault, ATSE will send start generator signal after time delay. Main power fault disappear and after time delay, ATSE will stop send start generator signal.</p>
 <p>⑥ ⑦</p>	<p>⑥ ⑦ Explain of these 2 terminal please see 6.3</p>

6.5 B type controller button function explain

Icon	Define	Explain
	Auto/Manual button (Setting button)	Used to choose in Manual mode or Automatic mode. Continue to click the button 10 times enter into the parameter setting mode. After transfer failure,used to cancel transfer failure status.
	Main power closing button (Turn page up button) (Increase button)	In Manual mode,used to close Main power. In Auto mode,used to query voltage and frequency of Main power and Emergency power. At parameter setting,used to turn page up or increase the numerical.
	Emergency power closing button (Turn page down button) (Decrease button)	In Manual mode,used to close Emergency power. At parameter setting,used to turn page down or decrease the numerical.
	Double off button (Confirm button) (Save data button)	In Manual mode,used to off the load. At parameter setting,used to confirm enter the menu or save data.

6.6 B type controller operation explain

When controller work normally,press "  ", controller could choose in Manual mode or Automatic mode. At this time,Manual indicator light lit or Auto indicator light lit.

If controller in Manual mode,press "  ",ATSE will transfer to Main power,press "  ",ATSE will transfer to Emergency power, press "  ",ATSE will off the load(Double off position).

Start generator signal output condition: When Main power occur over-voltage,under-voltage,phase loss etc. fault,ATSE will send start generator signal after time delay. Main power fault disappear and after time delay,ATSE will stop send start generator signal.

6.6 B type controller transfer failure alarm

When the controller send closing command(transfer to main power or transfer to emergency command),if have not detected closing signal in 10 second,it means closing failure.

When the controller send double off command, if detected main power or emergency power closing signal after 7 second,it means double off failure.

After transfer failure,controller display:"nErr",it means transfer to main power timeout. Controller display:"rErr",it means transfer to emergency power timeout. Controller display:"-Err",it means double off timeout.

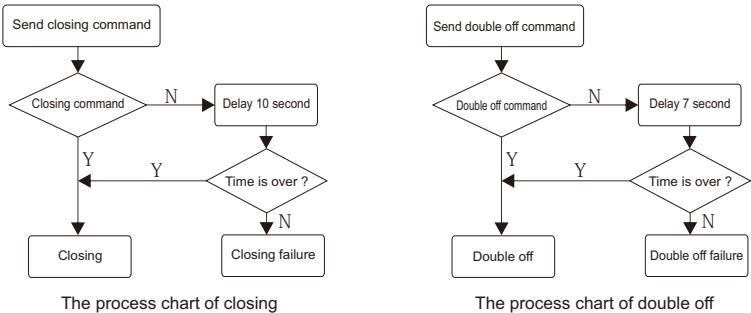









Figure 1 The process chart of closing and double off.

Note: Alarm reset:Click "  button. At this time,if ATSE is in automatic work status,ATSE will repeat operation according to Figure 1 process.

6.7 B type controller parameter setting

The way to enter into: Continue to click "  button 10 times enter into the menu of parameter amendment. The fourth code display flicker.

Amend parameter: Click "  button to turn page down or "  button turn page up. Click "  button to confirm enter into amend parameter. The last three code display flicker. Then click "Main" or "  " button to increase or decrease the number. Click "  button to save the parameter and into the next options.

Exit: In 10s no click action will automatic exit or click "  button 10 times to exit.

Note: If you have not click "  button to save the parameter,it will not save the amended parameter and exit directly.

6.8 B type controller voltage calibration operating process

The display voltage of B type controller has already be calibrated before leave factory. Normally user no need to calibrate. If under special circumstances, need to calibrate voltage, please according to following steps:

The way to enter into: In automatic work status, click " button 10 times enter into. The fourth code display "3" and flicker.



Calibrate voltage: Must debug all the main power and emergency power voltage to AC220V. Then click " button to save present calibrate data.



Exit: In 10s no click action will automatic exit or click " button 10 times to exit.

6.9 B type controller parameter content and range

In order to convenient for user, controller provide some common parameter for user modify. These common parameters has already be set before leave factory. In factory, the Settings of the parameters in detail as follows:

Parameter code	Parameter name	No.	Range	Default value
U 260	Main over-voltage threshold	1	AC230-AC300	260
u 175	Main under-voltage threshold	2	AC150-AC210	175
□ 010	Main voltage return value	3	0-50v	10
Γ 005	Main transfer delay time	4	0-240s	2
U.260	Emergency over-voltage threshold	5	AC230-AC300	260
u. 175	Emergency under-voltage threshold	6	AC150-AC210	175
□.010	Emergency voltage return value	7	0-50V	10
Γ .005	Emergency transfer delay time	8	0S-240S	2
q.005	Start generator delay time	9	0S-120S	5
d.005	Stop generator delay time	10	0S-120S	5
J.001	Machine address	11	1 - 32	1
b.001	Baud rate choose	12	1=2400 2=4800 3=9600 4=19200	3
E.000	Auto transfer and auto recovery, Auto transfer and non-auto recovery, As emergency for each other	13	0=Auto transfer and auto recovery, 1=Auto transfer and non-auto recovery, 2=As emergency for each other	0
F.001	Work frequency	14	1=50Hz(40-60)0=60Hz(50-70)	1
H.001	Restore the initial factory setting	15	1=Restore the initial factory setting	0

6.10 Transfer record query

The way to enter into: In automatic work status, meanwhile click "  " "  " button to enter into the recently transfer record.

Click "  " button to turn page down or "  " button to turn page up to query record.

E-01: Recently first transfer record.

E-02: Recently second transfer record.

E-03: Recently third transfer record.

Click "  " button to enter into query transfer reason.

u-00: Means no transfer record.

u-01: Means main A phase fault transfer record.

u-02: Means main B phase fault transfer record.

u-03: Means main C phase fault transfer record.

(Note: Fault only include phase loss, under-voltage, over-voltage record. Due to the power outage lead to ATSE transfer from main power to emergency power or transfer from emergency power to main power, fault will not make records.)

Exit: In 10s no click action will automatic exit.

6.11 Communication configuration and connection

This series ATSE controller has RS485 serial port, be allowed to connect the local area network with open structure. It's apply protocols of Mod Bus communication and value the PC or data acquisition system running software provide a simple practical dual power switch management plan to factories, telecom, industrial and civil building, achieve dual power monitor and "remote controlling, remote measuring, remote communication" functions.

Detail information of Communication protocol, please see "Q3 V1.0 communication protocol".

- Module address: 1 (range: 1-32, user can set it)
- Baud rate: 9600bps (option)
- Date bit: 8 bit
- Parity bit: None
- Stop bit: 1 or 2 bits

6.12 Troubleshooting and after-sales service

Fault phenomenon	Failure checking	Troubleshooting
Controller light is not bright after electrify	The power sampling wire fall off	To connect the corresponding wire
	3 pole switch,the neutral line have not connect to neutral terminal	
	The fuse of controller is fusing	Change fuse
Controller display phase loss	Input terminal of Corresponding circuit breaker contact undesirable, single-phase fault phase or the power voltage is below than the normal range.	To eliminate the power wire fault
Controller display normal but ATSE could not transfer normally	Test sliding plate if is in the "TEST" position	Push test sliding plate to "WORK" position
The power is normal and ATSE in ON position but load no electricity	Check the circuit breaker if is tripped	After load fault eliminate, please re-trip the circuit breaker by manual.



CERTIFICATE

Product Model: YCQ2 Series

Standard : IEC 60947-6-1

Inspector : CNC009

Production date: Printed on the product or package

This product is qualified after delivery inspection

CNC

YCQ2 Series

CNC ELECTRIC

Tel: 0086-577-61989999 Fax: 0086-577-61891122

www.cncele.com E-mail: cncele@cncele.com